

Catholic High School (Primary)
Primary 4 Science 2022
Practice Paper

Name: _____ ()

Class: Pri 4 _____

Date: _____

Parent's Signature: _____

Booklet A (15 × 2 marks)

For each question from 1 to 28, four options are given. One of them is the correct answer. Make your choice (1, 2, 3 or 4). Shade your answer on the Optical Answer Sheet. (30 marks)

- 1 To keep the floor dry in a building on a rainy day, people entering the building are to keep their wet umbrellas in umbrella bags placed at the entrance as shown in the diagram below.



What are the two most important properties the umbrella bag must have to best serve this purpose?

- A flexible
- B waterproof
- C able to float
- D allows most light to pass through

- (1) A and B only
- (2) A and D only
- (3) B and C only
- (4) C and D only

2 Some children were discussing about the human digestive system.

Peter Digestion of food starts in the stomach only.

Jenny Chewing our food is part of the digestion process.

Mary The digestive system only breaks down food but does not absorb food.

Who made the correct statement(s)?

- (1) Jenny
- (2) Peter and Mary
- (3) Mary and Jenny
- (4) Peter, Mary and Jenny

3 Janet magnetised an iron rod XY as shown in the diagram below.

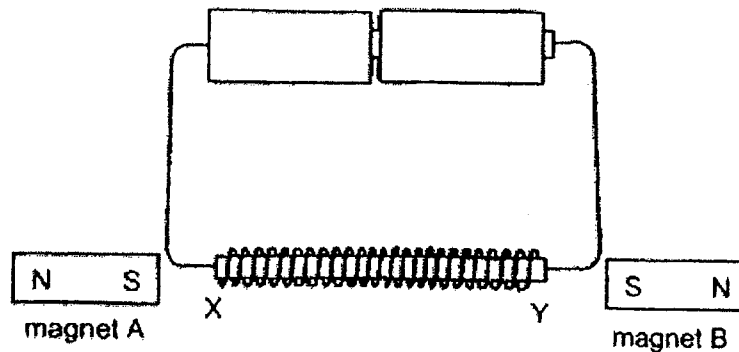

She observed that magnet A was attracted to the iron rod at point X while magnet B was repelled from the iron rod at point Y.

Based on Janet's observation, what would the poles X and Y of the iron rod be when it was magnetised?

	X	Y
(1)	North	South
(2)	North	North
(3)	South	North
(4)	South	South

- 4 The diagram below shows a toy that makes use of magnets. A ball with a magnet in it floats in between two magnets G and H.

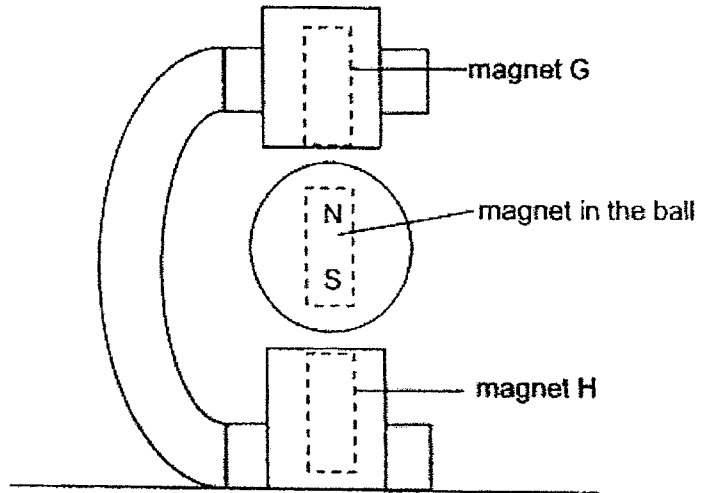

How should the magnets G and H be placed for the ball to float?

	magnet G	magnet H
(1)	<div style="border: 1px dashed black; padding: 5px; width: 40px; margin: 0 auto;"> N S </div>	<div style="border: 1px dashed black; padding: 5px; width: 40px; margin: 0 auto;"> N S </div>
(2)	<div style="border: 1px dashed black; padding: 5px; width: 40px; margin: 0 auto;"> N S </div>	<div style="border: 1px dashed black; padding: 5px; width: 40px; margin: 0 auto;"> S N </div>
(3)	<div style="border: 1px dashed black; padding: 5px; width: 40px; margin: 0 auto;"> S N </div>	<div style="border: 1px dashed black; padding: 5px; width: 40px; margin: 0 auto;"> S N </div>
(4)	<div style="border: 1px dashed black; padding: 5px; width: 40px; margin: 0 auto;"> S N </div>	<div style="border: 1px dashed black; padding: 5px; width: 40px; margin: 0 auto;"> N S </div>

- 5 Daryl grew some green bean seeds in a cup and placed it near a window. He then measured the height of the seedlings every four days.

Which one of the following graphs best represents the height of the seedlings over 16 days?

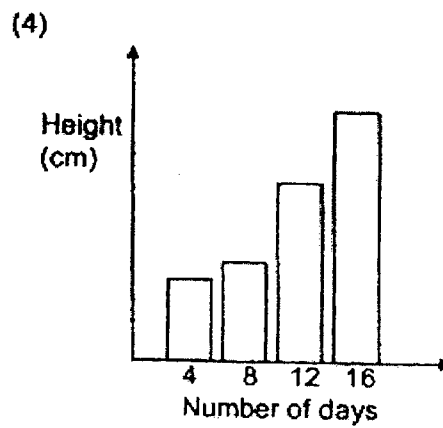
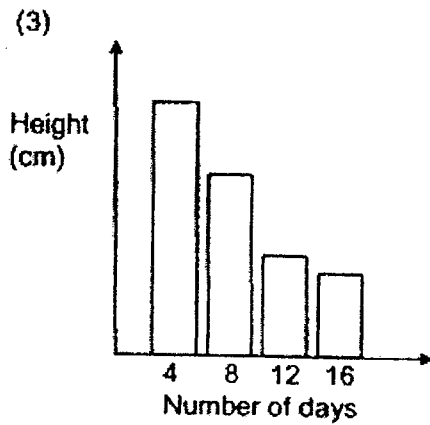
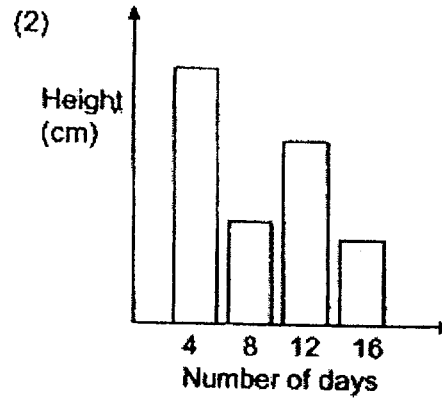
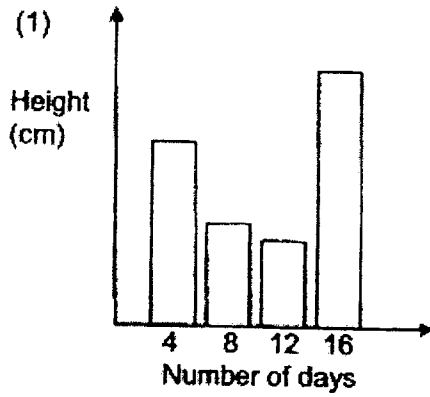

- 6 The graph below shows the length of each stage in the life cycle of an insect.

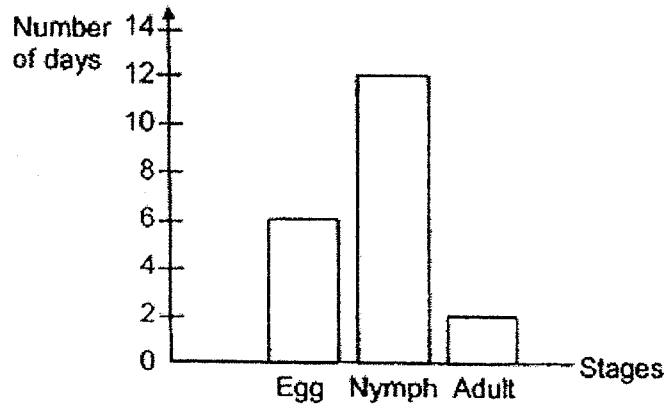

How many days would it take for the insect to become an adult after the egg is laid?

- (1) 6
 - (2) 12
 - (3) 18
 - (4) 20
- 7 Three identical glasses contained the following objects.

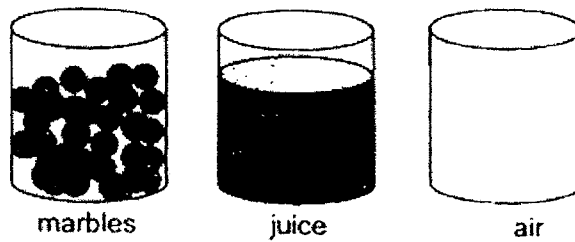

A jug of water was poured into each glass at the same time.

In what order, from first to last, would the water overflow?

	First	→	Last
(1)	air		marbles
(2)	marbles		air
(3)	juice		air
(4)	marbles		juice

- 8 Abdul prepared two identical syringes, A and B, each containing different types of matter, X and Y.

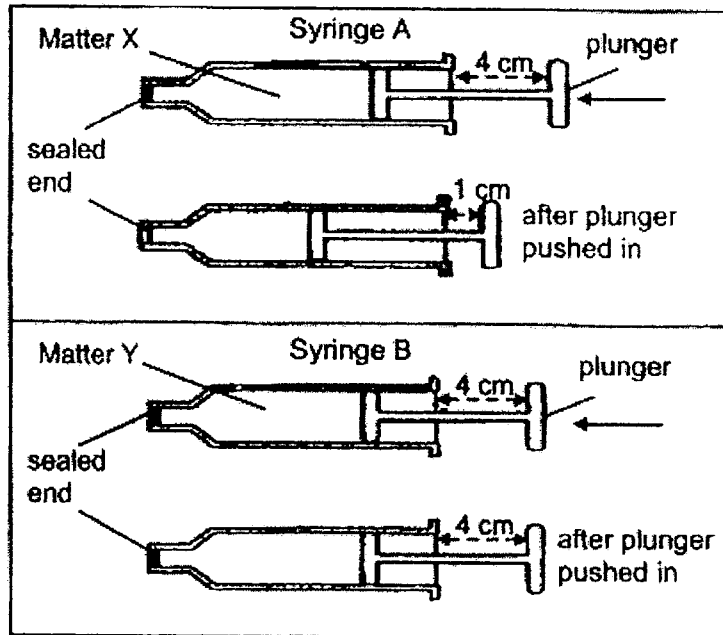

Abdul tried pushing the plunger in each syringe and observed what happened. He recorded the distance moved by each syringe in the table below.

Syringe	Distance moved by plunger (cm)
A	3
B	0

Which one of the following correctly identifies X and Y?

	X	Y
(1)	oil	sand
(2)	rice	oxygen
(3)	air	milk
(4)	water	sugar

- 9 Gopal set up an experiment as shown below. He placed object A 10 cm away from the torch and the light sensor 10 cm away from the object.

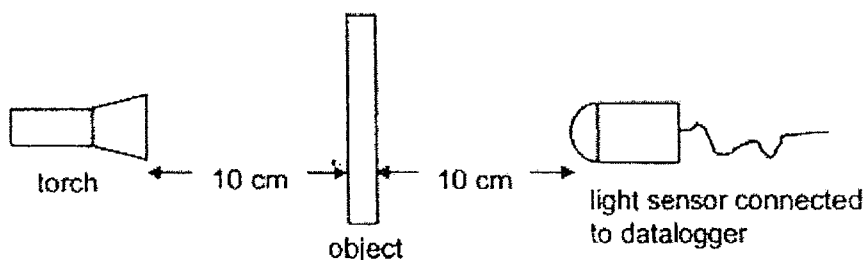

He repeated the same experiment using objects, B, C and D. The four objects, A, B, C and D, were similar in size and thickness, but were made of different materials. He recorded the amount of light detected by the light sensor in the table below.

Object	Amount of light detected by light sensor (units)
A	0
B	425
C	150
D	259

What was the aim of Gopal's experiment?

- (1) To find out how the thickness of the object affects the amount of light passing through.
- (2) To find out how the amount of light passing through the object affects the materials used.
- (3) To find out how the materials used affects the amount of light passing through the object.
- (4) To find out how the position of the light source affects the amount of light passing through the object.

- 10 The diagram below shows three identical balls, A, B and C, placed at different distances in front of a screen. A light source was switched on and the shadows of the balls were cast on the screen.

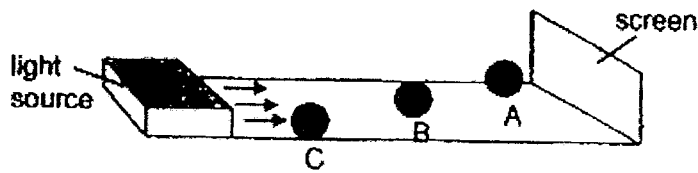

Assuming the balls do not block one another, which one of the following diagrams correctly shows the shadows of the balls, A, B and C, on the screen?

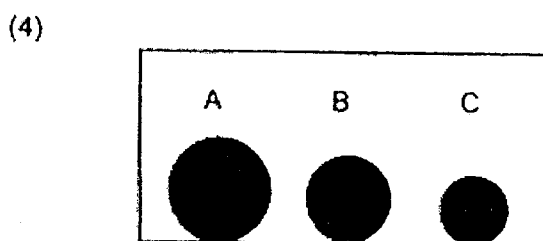
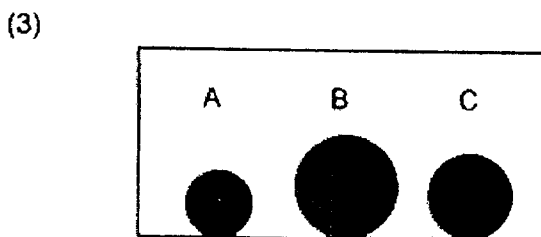
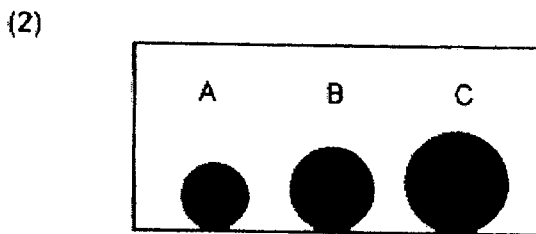
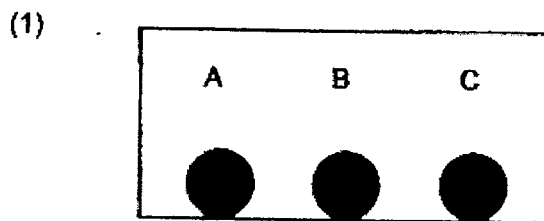

11 The diagram below shows a shadow formed on a screen.

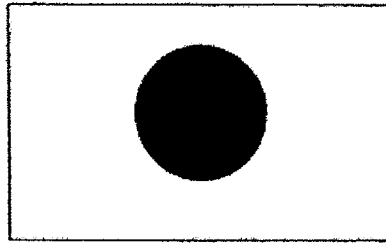

Which of the following could not have formed the shadow shown above?

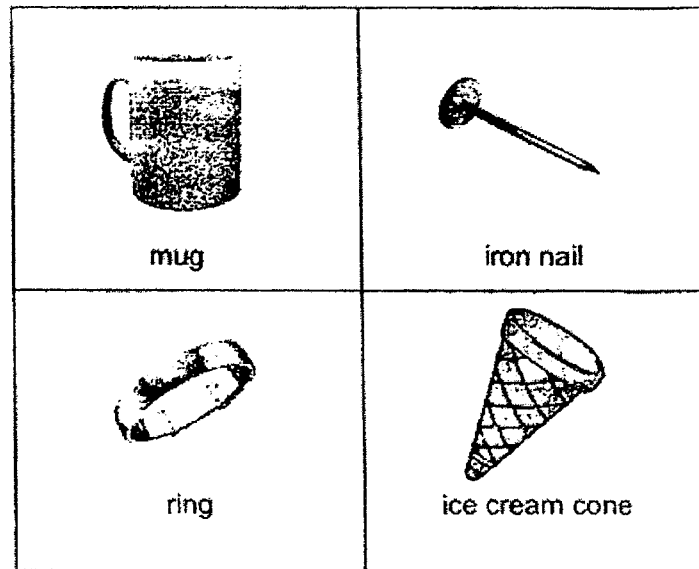

- (1) ring and mug
- (2) mug and iron nail
- (3) ice cream cone and ring
- (4) iron nail and ice cream cone

- 12 Nancy poured some hot milk into a cup as shown below. She wanted to keep her milk hot for as long as possible.

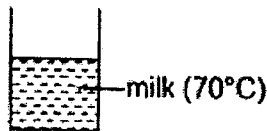

Which one of the following arrangements is the best method to keep the milk hot for the longest time?

(1)

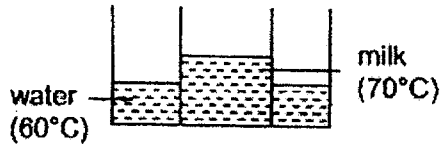

(2)

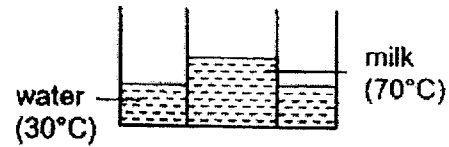

(3)

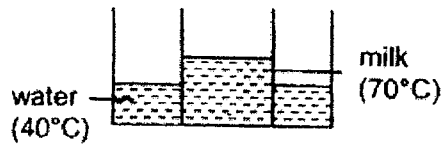

(4)

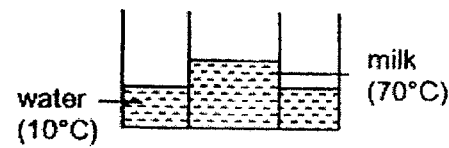

- 13 Some ice cubes are put into a glass of drink. The ice cubes melt after a while.



How does adding ice cubes make the drink colder?

- (1) The ice cubes melt so there is more drink.
- (2) The ice cubes gain heat from the drink as they melt.
- (3) The heat from the ice cubes moves to the drink as they melt.
- (4) The heat from the ice cubes moves to the glass holding the drink.

- 14 Matter can exist in three states, solid, liquid or gas, depending on the temperature.

The diagram below shows how matter can change from one state to another.

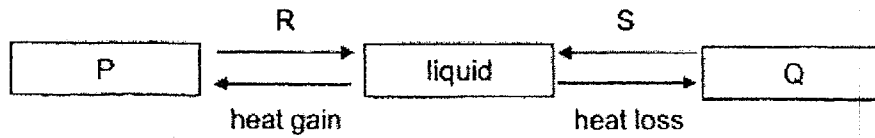

What could P, Q, R and S be?

	P	Q	R	S
(1)	gas	solid	heat gain	heat loss
(2)	solid	gas	heat gain	heat loss
(3)	solid	gas	heat loss	heat gain
(4)	gas	solid	heat loss	heat gain

- 15 Joe carried out an experiment to find out how well different materials reduce heat loss.

He wrapped three identical empty drink cans in different materials. He then put equal amounts of water at 50°C into each can.

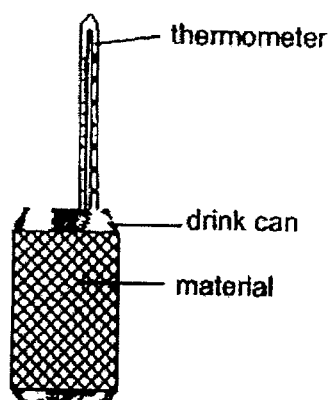

After five minutes, he measured the temperature of the water and recorded it in the table below.

Material	Temperature of water after five minutes (°C)
A	39
B	45
C	42

Which one of the following lists the materials from the most effective at reducing heat loss to the least effective?

- (1) B, C, A
- (2) B, A, C
- (3) C, B, A
- (4) A, C, B

End of Booklet A

**Catholic High School (Primary)
Primary 4 Science 2022
Practice Paper**

Booklet A	30
Booklet B	25
Total	55

Name: _____ ()

Class: Pri 4 _____

Date: _____

Parent's Signature: _____

Booklet B (25 marks)

For questions 16 to 22, write your answers in this booklet.

The number of marks available is shown in brackets [] at the end of each question or part question. (25 marks)

- 16 Some children wanted to find out which material keeps a drink hot for the longest period of time. They filled three containers, A, B and C, with hot water. They placed them at the same place.



What other variables must be kept the same for the experiment to be fair? Put a tick (✓) in the correct boxes. [2]

Variables	Kept constant
Size of containers	<input type="checkbox"/>
Material of containers	<input type="checkbox"/>
Volume of water in containers	<input type="checkbox"/>
Final temperature of water in containers	<input type="checkbox"/>

(Go on to the next page)

SCORE	2
-------	---

17 The diagram below shows the human digestive system.

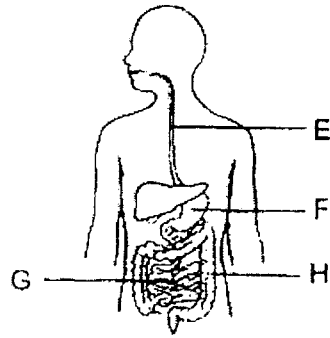

(a) Name the parts of the digestive system represented by F and H. [1]

F: _____

H: _____

(b) In which part(s), E, F, G and H, is/are digestive juices added? [1]

(c) Explain what happens at parts G and H. [2]

G: _____

H: _____

(Go on to the next page)

SCORE	4
-------	---

18 Jeremy wanted to make a magnet using the electrical method.

- (a) Other than a battery, what other items would he need?
Tick (✓) the correct box(es).

[1]

Items	Tick (✓)
iron rod	
aluminium rod	
copper wire	
eraser	

- (b) When he tested the electromagnet that he had made, he had the following results.

	plastic clips	steel clips
Number of clips attracted	0	4

He re-constructed his electromagnet and tested again. The number of steel clips attracted increased. Predict the number of plastic clips attracted by writing your prediction in the table below.

[1]

	plastic clips	steel clips
Number of clips attracted	_____	8

- (c) Give a reason for your answer in (b).

[1]

- (d) Without replacing any of the items or adding new items, suggest what he had done to the electromagnet in order to attract 8 steel clips.

[1]

(Go on to the next page)

SCORE	4
-------	---

19 Study the chart below.

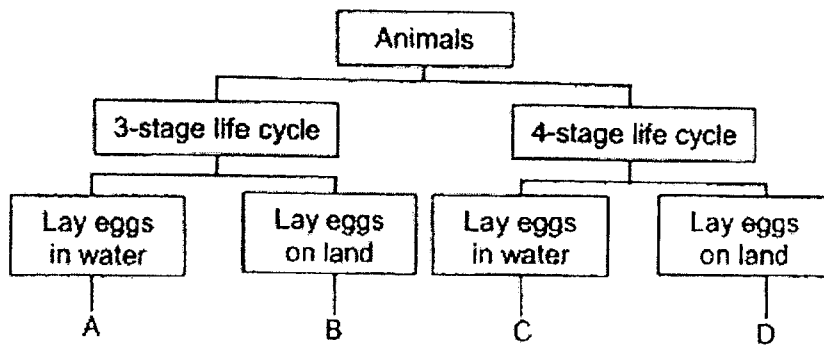

(a) Based on the chart above, state one difference between animals B and D. [1]

(b) Which animal, A, B, C or D, represents a beetle? [1]

(c) Jack placed a butterfly egg in a sealed jar as shown. After one week, the egg hatched into a larva.

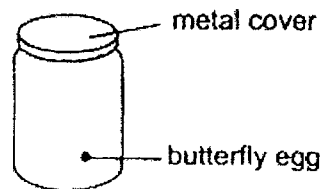

Give two suggestions how Jack can improve the above set-up to ensure that the butterfly larva survives after it hatches. [2]

Suggestion 1 : _____

Suggestion 2 : _____

(Go on to the next page)

SCORE	4
-------	---

- 20 Justin conducted an experiment with two identical jars, X and Y, of capacity 300 cm^3 . Each jar contained 300 cm^3 of air.

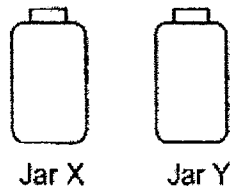

- He connected a pump to both jars as shown in the diagram below. He then pumped in another 100 cm^3 of air into Jar X. Both jars were then placed on a balance.

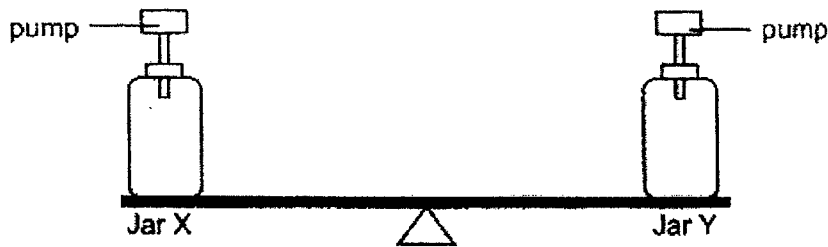

- (a) State what would happen to the balance after 100 cm^3 of air was pumped into Jar X. [1]

- (b) What was the final volume of air in Jar X? [1]

_____ cm^3

- (c) State one property of air that is shown in the experiment above. [1]

(Go on to the next page)

SCORE	3
-------	---

- 21 The set-up below shows light from a torch shining on two shapes, S and T, made from thick cardboard. The shapes are placed at different distances from the torch.

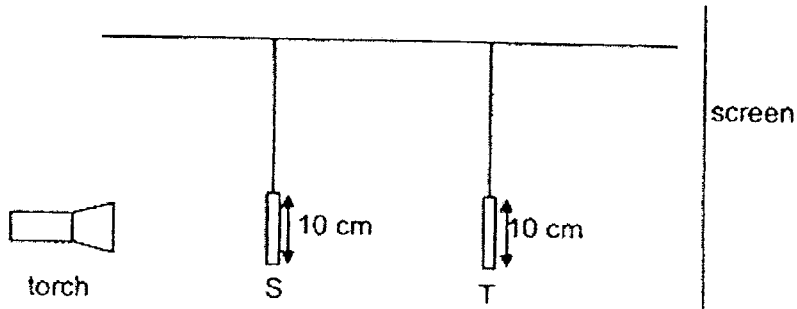

The diagram below shows the shadow that was formed on the screen.

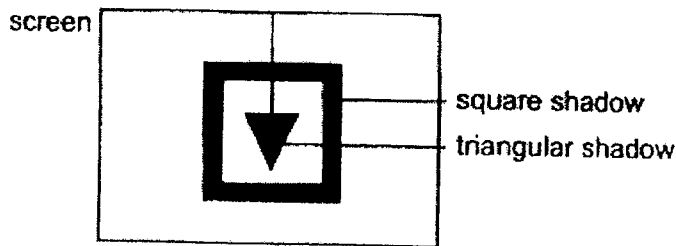

- (a) Which shape, S or T, is a triangle? [1]

- (b) Suggest one way to increase the size of the triangular shadow without changing the size of the square shadow. (You cannot add, remove or replace any of the materials.) [1]

(Go on to the next page)

SCORE	2
-------	---

Continue from question 21

Object T was removed and the distance between the torch and the screen was changed.

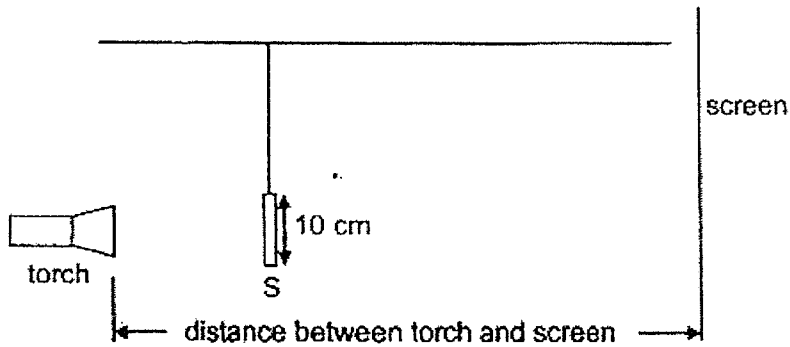

The height of the shadow formed on the screen was recorded in the table below.

Distance between torch and screen (cm)	Height of shadow (cm)
60	28
55	30
50	32
45	X
40	36

- (c) Based on the table above, what could be the value of X? [1]

- (d) Based on the table above, what is the relationship between the distance between the torch and the screen and the height of the shadow? [1]

(Go on to the next page)

SCORE	2
-------	---

- 22 Mike filled a jar with some water at a temperature of 90°C . He placed an ice cube into it as shown in the diagram below.

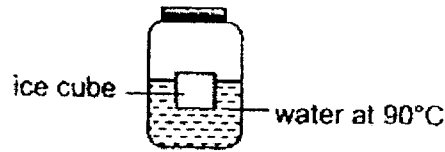

- (a) Would the temperature of the water in the jar after five minutes be higher than, same as or lower than 90°C ? Give a reason why. [2]

- (b) Mike placed four similar ice cubes in four jars, K, L, M and N which were of similar size but made of different materials. He left the jars on a table in the living room.

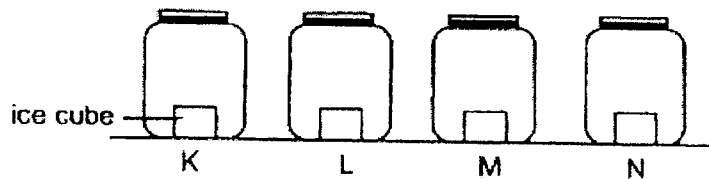

He recorded the time taken for the ice to melt completely and plotted the readings in the graph below.

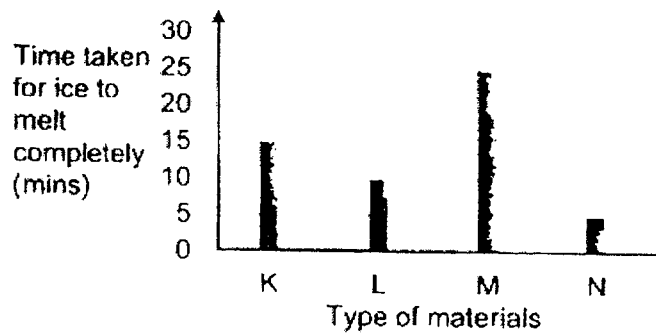

- Which material is most suitable to make an ice cream container so that the ice cream will not melt so quickly? Explain your answer. [2]

End of Booklet B

SCORE	4
-------	---

YEAR :
 LEVEL : PRIMARY 4
 SCHOOL : CATHOLIC HIGH SCHOOL (PRIMARY)
 SUBJECT : SCIENCE
 TERM : PRACTICE PAPER

BOOKLET A

Q1	1	Q2	1	Q3	1	Q4	3	Q5	4
Q6	3	Q7	3	Q8	3	Q9	3	Q10	2
Q11	1	Q12	1	Q13	2	Q14	4	Q15	1

BOOKLET B

Q16	Size of containers		
	Volume of water in containers		
Q17	(a) F : stomach H : large intestine		
	(b) F and G		
	(c) G : Digestion ends. Digested food is absorbed into the bloodstream. H : Absorbs water and changes the waste into stool		
Q18	(a) iron rod copper wire		
	(b) 0		
	(c) The plastic clip is a non-magnetic object.		
	(d) Increase the number of coils around the iron rod.		
Q19	(a) B has a 3-stage life cycle while D has 4-stage life cycle.		
	(b) D		
	(c) Suggestion 1 : Poke holes in the metal cover. Suggestion 2 : Put leaves inside the jar.		
Q20	(a) The balance would move down the side of jar X.		
	(b) 300 cm ³		
	(c) Air does not have definite volume.		
Q21	(a) T		
	(b) Move the triangular closer to the torch		
	(c) 34		
	(d) As the distance between the torch and the screen decrease, the height of the shadow increases.		
Q22	(a) Lower than 90°. The water lost heat to the ice cube and the surrounding.		
	(b) M. The ice in jar took the longest time to melt completely so is the poorest conductor of heat and the ice will take longer to melt		

